

PRELIMINARY
PART IN DESIGN
SUBJECT TO CHANGE

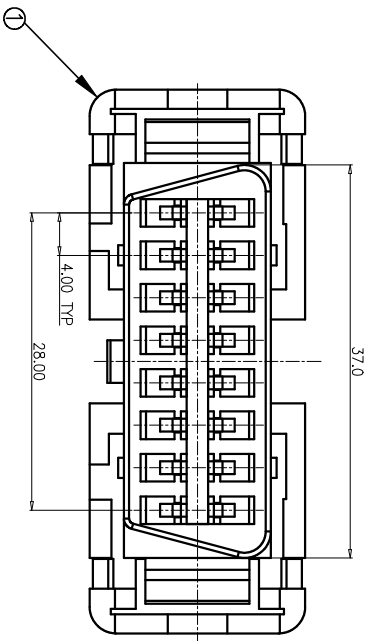

HOUSING

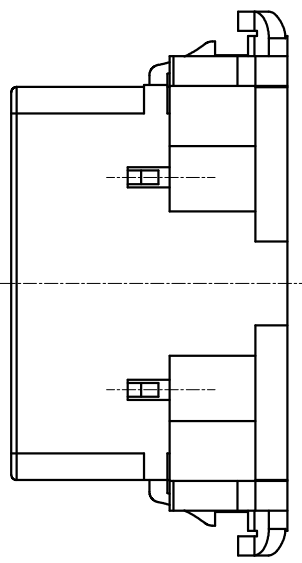
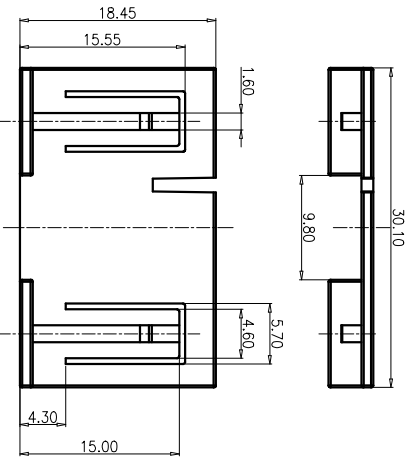

FIXER

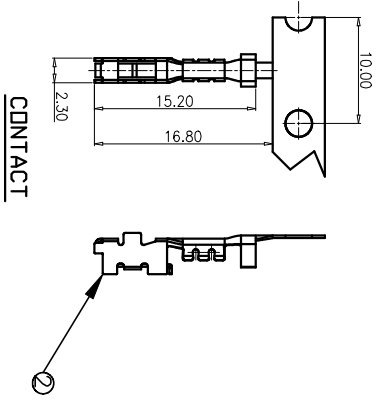
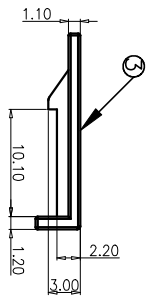

CONTACT

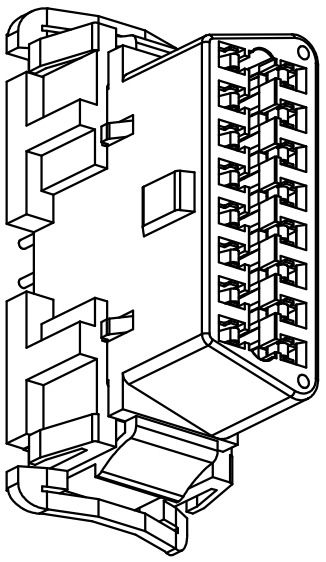
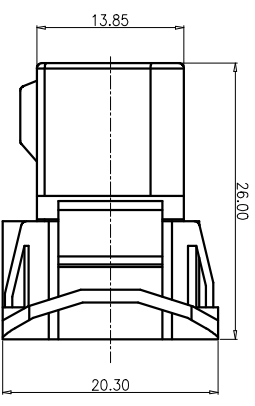

CUSTOMER

REV. A	PART-NO. RFO-1508190003 DCN-1601015	DESCRIPTION NEW RELEASE	ISSUED 2016/01/11 Alexis
--------	--	-------------------------	-----------------------------

1. ELECTRICAL SPECIFICATION :
 - 1-1. Rated current : 4A
 - 1-2. Voltage :30V
2. Environmental :
 - 2-1. Operation Temperature : -40°C~85°C

<input checked="" type="checkbox"/> FIXER	PA66+15%GF	UL94V-0, BLACK	2																		
<input checked="" type="checkbox"/> CONTACT	PHOSPHOR BRONZE	TIN 60u" MIN. OVER NI 60u" MIN.	16																		
<input checked="" type="checkbox"/> HOUSING	PA66	UL94V-0, BLACK	1																		
ITEM DESCRIPTIONS																					
<input type="checkbox"/> LEAD-FREE		<input type="checkbox"/> HALOGEN-FREE																			
UNLESS OTHERWISE SPECIFIED DIMENSION ARE IN MILLIMETER TOLERANCE DECIMALS ANGLES																					
X ± 0.20	X' ± 0.10	X ± 0.20	X' ± 0.10																		
<table border="1"> <tr> <td>SIMULA SPECIAL TECHNOLOGY SOLUTION SERVICE</td> <td>PART NO. HJ5BD2-GB7R-R2F</td> <td>TITLE OBDII Receptacle Con. (Crimp type)</td> </tr> <tr> <td>APPROVALS</td> <td>DATE 2016/01/11</td> <td>SIZE TENSION A4</td> </tr> <tr> <td>DRM Alexia</td> <td>2016/01/11</td> <td>COSS NO. X1</td> </tr> <tr> <td>CHECKED Thomas</td> <td>2016/01/11</td> <td>SCALE N/A</td> </tr> <tr> <td>APPROVED Jonel</td> <td>2016/01/11</td> <td>UNIT mm</td> </tr> <tr> <td colspan="2">CONFIDENTIAL</td> <td>SHEET 1/1</td> </tr> </table>				SIMULA SPECIAL TECHNOLOGY SOLUTION SERVICE	PART NO. HJ5BD2-GB7R-R2F	TITLE OBDII Receptacle Con. (Crimp type)	APPROVALS	DATE 2016/01/11	SIZE TENSION A4	DRM Alexia	2016/01/11	COSS NO. X1	CHECKED Thomas	2016/01/11	SCALE N/A	APPROVED Jonel	2016/01/11	UNIT mm	CONFIDENTIAL		SHEET 1/1
SIMULA SPECIAL TECHNOLOGY SOLUTION SERVICE	PART NO. HJ5BD2-GB7R-R2F	TITLE OBDII Receptacle Con. (Crimp type)																			
APPROVALS	DATE 2016/01/11	SIZE TENSION A4																			
DRM Alexia	2016/01/11	COSS NO. X1																			
CHECKED Thomas	2016/01/11	SCALE N/A																			
APPROVED Jonel	2016/01/11	UNIT mm																			
CONFIDENTIAL		SHEET 1/1																			



3rd ANGLE PROJECTION